

# ROBOTA

## PRODUKTBLAD

UNIVERSALPUMP 40/12M MAN  
1x230 VOLT



UNIVERSALPUMP IDROGO 40/12M 1582060021

Artnr	Kabel	Volt	Amp	Watt	H max	Q max	temp	Vikt	Anslut
496415	20 meter	1x230 V	6,8A	900 W	72 meter	80 l/min	40°C	Ca 17,2 Kg	R32 inv

# ROBOTA

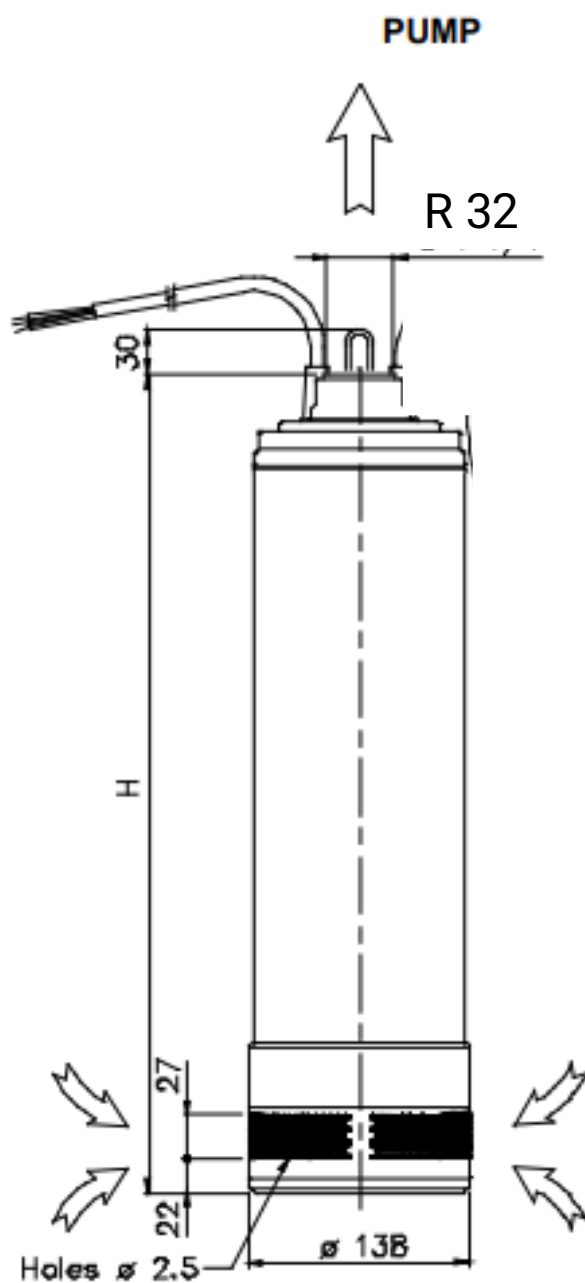

Pumptyp	H
UE 40/12	590

# ROBOTA

## PUMPKURVA 40/12

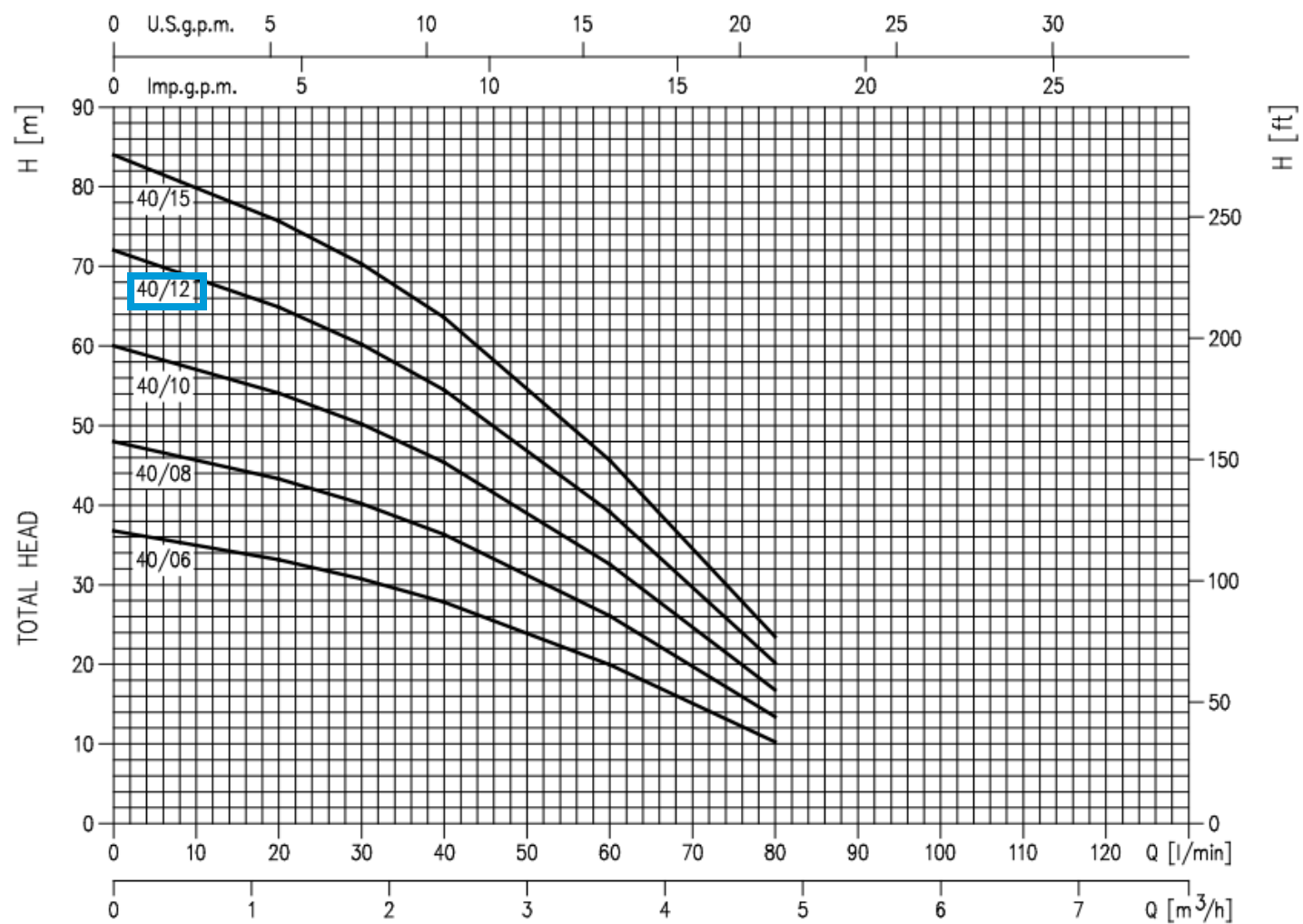

# ROBOTA

PUMPTYP	PUMPHJUL	DIFFUSORER	PUMPHJULSHUS
UE 40/12	6	5	6

## Motorsida

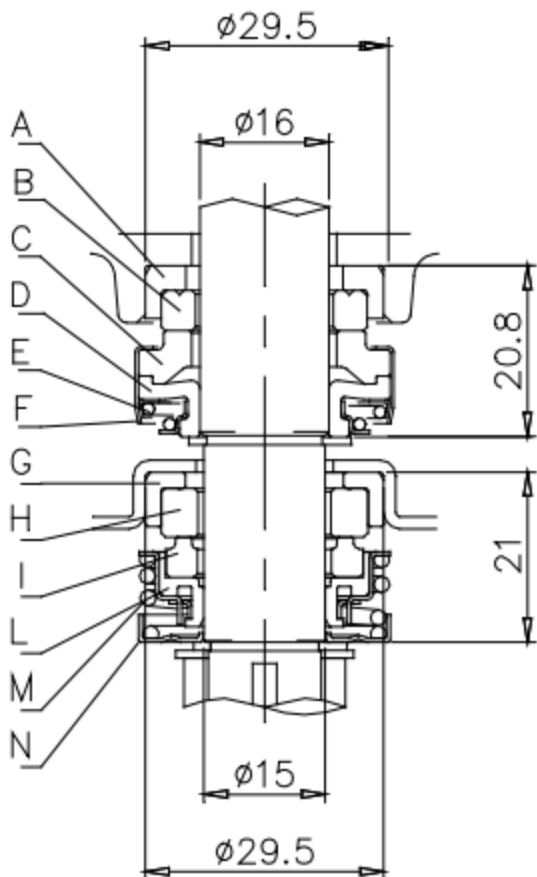

## Pumpsida

Ref.	Namn	Material
A	Gummisäte	NBR
B	Fast tätning	Keramik
C	Roterande tätning	Kol
D	Roterande gummi	NBR
E	Fjäder	AISI 304
F	Täckbricka tätning	AISI 304
G	Gummisäte	NBR
H	Fast tätning	Sic
I	Roterande tätning	Kol
L	Roterande gummi	NBR
M	Fjäder	AISI 304
N	Täckbricka tätning	AISI 304